

# PATENT ABSTRACTS OF JAPAN

(11)Publication number : 2001-324403

(43)Date of publication of application : 22.11.2001

---

(51)Int.Cl.

G01L 21/12

---

(21)Application number : 2000-139780

(71)Applicant : YOKOGAWA ELECTRIC CORP

(22)Date of filing : 12.05.2000

(72)Inventor : KISHI NAOTERU  
HARA HITOSHI

---

(54) VACUUM MEASUREMENT DEVICE

(57)Abstract:

PROBLEM TO BE SOLVED: To provide a vacuum measurement device having small size and small individual difference in characteristics and capable of stable mass production.

SOLUTION: In a vacuum measurement device for measuring the pressure of gas by heating a filament touching the gas to be measured and measuring the quantity of heat taken out of the filament, the filament is formed in microbridge-shape on a substrate.

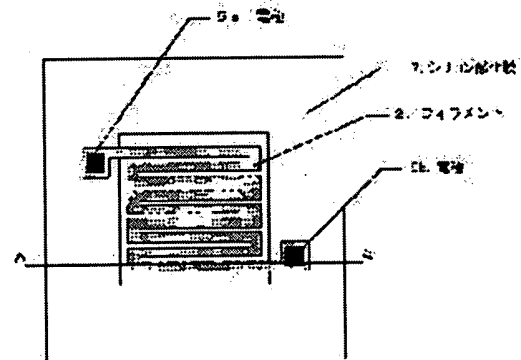

---

## LEGAL STATUS

[Date of request for examination]

[Date of sending the examiner's decision of rejection]

[Kind of final disposal of application other than the examiner's decision of rejection or application converted registration]

\* NOTICES \*

JPO and NCIPI are not responsible for any damages caused by the use of this translation.

1. This document has been translated by computer. So the translation may not reflect the original precisely.
2. \*\*\*\* shows the word which can not be translated.
3. In the drawings, any words are not translated.

---

DETAILED DESCRIPTION

---

[Detailed Description of the Invention]

[0001]

[Field of the Invention] This invention relates to the degree of vacuum measuring device which measures a gaseous degree of vacuum by detecting the heating value taken from a filament.

[0002]

[Description of the Prior Art]

[0003] Drawing 6 is the block diagram of the conventional degree of vacuum measuring device. drawing 6 -- it is and the degree of vacuum measuring device consists of the metaled cylinder 20, a filament 21 of the platinum prepared in the interior of cylindrical, and electrodes 22a and 22b. It connects with Electrodes 22a and 22b, and those both ends can energize a filament from the exterior on a filament 21 through this electrode.

[0004] And a filament 21 will be heated by own resistance, if the vacuum housing which does not illustrate a cylinder is made open for free passage and it energizes on a filament 21. And heat is taken from a filament 21 by that the gas molecule in a vacuum housing collides with a filament 21, radiation, or solid-state heat conduction to Electrodes 22a and 22b.

[0005] In this case, when the taken heating value  $Q$  sets resistance of a filament 21 to  $R$  and it sets the energized current to  $I$ , it is shown by  $Q=I^2R$ , and this heating value measures the degree of vacuum in a vacuum housing from it being dependent on the pressure in a vacuum housing based on the heating value  $Q$  computed.

[0006] Measure change of the temperature of a filament 21 as change of resistance of a filament 21, use a filament 21 as resistance which constitutes a bridge circuit, it is made for the current which flows to a bridge circuit to become fixed with change of a gaseous pressure, and this regards change of the unbalanced current of a bridge as change of a pressure.

[0007]

[Problem(s) to be Solved by the Invention] However, there were the following troubles in such a degree of vacuum measuring device.

- (1) In manufacture of a degree of vacuum measuring device, it is difficult to mass-produce at once, and there is a solid-state difference in a property.
- (2) Since the heat loss of the filament by heat conduction to an electrode is changed by the temperature change of an environmental measurement environment, it worsens the precision of a pressure survey. Therefore, in order to lessen this effect relatively, it is necessary to lengthen the die length of a filament to some extent but, and since it becomes easy to cut a filament corresponding to die length, it becomes difficult to miniaturize equipment.

[0008] It is small by being made in order that this invention may solve the trouble mentioned above, and forming a filament in a semi-conductor substrate in the shape of a microbridge, there are few solid-state differences in a property, and it aims at being stabilized and offering the degree of vacuum measuring device which can be mass-produced.

[0009]

[Means for Solving the Problem] In claim 1 of this invention, said filament is a degree of vacuum measuring device characterized by being formed in a substrate in the shape of a microbridge in the degree of vacuum measuring device which measures the pressure of said gas by measuring the heating value which heats the filament in contact with a measured gas, and is taken from this filament.

[0010] In claim 2 of this invention, said substrate is a silicon substrate, and said filament is a degree of vacuum measuring device according to claim 1 which patterning is carried out and is characterized by being formed in the shape of [ said ] a microbridge by etching and removing said silicon substrate of the lower part by etching the impurity diffused layer formed in said silicon substrate.

[0011] In claim 3 of this invention, said substrate is a silicon substrate. Said filament is a degree of vacuum measuring device according to claim 1 which patterning is carried out and is characterized by being formed in the shape of [ said ] a microbridge by etching and removing said silicon substrate of the lower part by etching the polycrystalline silicon layer formed in said silicon substrate through the insulator layer.

[0012] In claim 4 of this invention, said substrate is a SOI substrate with which the single-crystal-silicon layer was formed through the insulator layer on the single crystal silicon substrate, and said filament is a degree of vacuum measuring device according to claim 1 which patterning is carried out and is characterized by being formed in the shape of [ said ] a microbridge by etching and removing said single crystal silicon substrate of the lower part by etching said single-crystal-silicon layer.

[0013] In claim 5 of this invention, it is the degree of vacuum measuring device according to claim 1 characterized by preparing the corrosion prevention film in said filament.

[0014] In claim 6 of this invention, said corrosion prevention film is a degree of vacuum measuring device according to claim 4 characterized by being the silicon oxide film.

[0015] In claim 7 of this invention, said corrosion prevention film is a degree of vacuum measuring device according to claim 4 characterized by being a silicon nitride film.

[0016]

[Embodiment of the Invention] Next, the example of this invention is explained using a drawing. Drawing 1 is a top view common to the first of this invention, and the second and third examples, and drawing 2 (a), (b), and (c) are the A-A' sectional views of the degree of vacuum measuring device shown in drawing 1, and are the sectional view of the first example, the second example, and the third example, respectively.

[0017] First, the first example of this invention is explained. In drawing 1 and drawing 2 (a), the degree of vacuum measuring device is formed so that the microbridge-like filament 2 may be fixed to a silicon substrate 1 by the both ends of the ditch 3 formed at the silicon substrate 1.

[0018] After boron forms the impurity diffused layer 4 doped by high concentration on a silicon substrate 1, a filament 2 carries out patterning of this impurity diffused layer 4a to the MIANDA mold with which two or more bays were turned up by photo etching, and forms that flat-surface configuration.

[0019] Next, after forming the silicon oxide for etching masks (not shown) in the rear face of a silicon substrate 1, the metal membrane for electrodes is formed on impurity diffused layer 4a, and Electrodes 5a and 5b are formed by photo etching.

[0020] And by using the silicon oxide for etching masks as a mask, when an anisotropy carries out concentration difference etching of the silicon substrate 1 of the filament 2 lower part, a ditch 3 is formed, a filament 2 floats in the hollow on a ditch 3, and the microbridge structure where the both ends were fixed to the both ends of a ditch 3 is formed.

[0021] Concentration difference etching is performed by carrying out anisotropic etching of the silicon substrate 1 using KOH as a solution of the alkali system from which the etch rate of silicon differs according to a concentration difference. In this case, since the filament 2 is formed of impurity diffused layer 4a with high high impurity concentration, it will remain, without being etched by concentration difference etching.

[0022] And the silicon oxide 6 as corrosion prevention film is formed so that a filament 2 may be covered.

[0023] Next, the second example of this invention is explained. In drawing 1 and drawing 2 (b), the degree of vacuum measuring device is formed so that the microbridge-like filament 2 may be fixed to a silicon substrate 1 by the both ends of the ditch 3 formed at the silicon substrate 1.

[0024] After a filament 2 forms polycrystalline silicon layer 4b by which boron was doped by high concentration on the silicon oxide 7 formed on the silicon substrate 1, that flat-surface configuration is formed by carrying out patterning of this polycrystalline silicon layer 4b to the MIANDA mold with which two or more bays were turned up.

[0025] And by using as a mask the silicon oxide (not shown) formed in both sides of a silicon substrate 1, when an anisotropy carries out concentration difference etching of the silicon substrate 1 of the filament 2 lower part, a ditch 3 is formed, a filament 2 floats in the hollow on a ditch 3, and the microbridge structure where the both ends were fixed to the both ends of a ditch 3 is formed.

[0026] And after forming the metal membrane for electrodes on polycrystalline silicon layer 4b, while forming Electrodes 5a and 5b by photo etching, the silicon oxide 6 as corrosion prevention film is formed so that a filament 2 may be covered.

[0027] Next, the third example of this invention is explained. In drawing 1 and drawing 2 (c), the degree of vacuum measuring device is formed so that the microbridge-like filament 2 may be fixed to the SOI substrate 8 by the both ends of the ditch 3 formed at the SOI substrate 8.

[0028] As for the SOI substrate 8, single-crystal-silicon layer 4c is formed through the silicon oxide 7 as an insulator layer on the single crystal silicon substrate 9. In this case, single-crystal-silicon layer 4c is silicon of P type with high high impurity concentration.

[0029] First, after forming the silicon oxide for etching masks (not shown) in both sides of the SOI substrate 8, the metal membrane for electrodes is formed on single-crystal-silicon layer 4c, and Electrodes 5a and 5b are formed by photo etching.

[0030] And a ditch 3 is formed by carrying out patterning of the silicon oxide (not shown) of the rear face of the SOI substrate 8, and carrying out anisotropic etching of the single crystal silicon substrate 9 of the filament 2 lower part by making this into a mask.

[0031] And after removing the silicon oxide which remained, patterning is carried out to the MIANDA mold with which photo etching of the single-crystal-silicon layer 4c was carried out, and two or more bays were turned up, and the filament 2 of the shape of a microbridge which was fixed to the both ends of a ditch 3 and floated in the hollow on a ditch 6 is formed.

[0032] And the silicon oxide 6 as corrosion prevention film is formed so that a filament 2 may be covered.

[0033] In addition, for a start which was mentioned above, it can also consider as a spiral mold as shows the flat-surface configuration of the degree of vacuum measuring device of the second and third examples to drawing 3, and the silicon oxide 6 as corrosion prevention film can also be transposed to a silicon nitride film.

[0034] And as shown in drawing 4 R> 4, die bonding of the above degree of vacuum measuring devices is carried out to a stem 10, wirebonding of the electrodes 5a and 5b is carried out to the external electrodes 10a and 10b, and it installs in the vacuum housing (not shown) which measures a degree of vacuum. And it energizes to Electrodes 5a and 5b through the external electrodes 10a and 10b, a filament 5 is heated, and the degree of vacuum in a vacuum housing is measured.

[0035] A check of operation is carried out about an above-mentioned degree of vacuum measuring device, and the acquired operating characteristic is shown in drawing 5. Drawing 5 shows the relation between a degree of vacuum and inter-electrode electrical-potential-difference rate of change in three sorts of currents energized on a filament. In drawing 5, the field where electrical-potential-difference rate of change is not saturated, i.e., the measurable field which is 1.00Pa - about  $1.00 \times 10^3$ Pa, was able to be obtained.

[0036] In the above vacuum measuring devices, it is possible to be able to lessen the difference of the property between solid-states with a semi-conductor micro machine technique, and to manufacture in large quantities at once.

[0037] Moreover, the stable actuation can be secured, without a filament corroding in a corrosion-

resistant gas ambient atmosphere, since the corrosion prevention film was prepared in the filament. Therefore, it is possible to apply to degree of vacuum measurement of the decompression device used for the semiconductor fabrication machines and equipment which use corrosive gas.

[0038] Moreover, since it is possible to control resistance of a filament 2 to a desired value by controlling the high impurity concentration of impurity diffused layer 4a, polycrystalline silicon layer 4b, and single-crystal-silicon layer 4c by an ion implantation etc., relation between the noise (few in a high-concentration case) of a resistor and a temperature coefficient of resistance (large in a low-concentration case) can be made the optimal.

[0039] Moreover, since it has structure which could lengthen the die length enough and floated in midair since the configuration of a filament was used as the MIANDA mold or the spiral mold, the touch area to the gas of a filament can be made large. Therefore, the amount which radiates heat through a substrate or an electrode from a filament 2 can be lessened, thermal conductance can be improved, and the detection sensitivity of a degree of vacuum can be maintained highly.

[0040]

[Effect of the Invention] Since the filament was formed in the semi-conductor substrate in the shape of a microbridge from claim 1 of this invention according to claim 4 as explained above, it is small and there are few solid-state differences in a property, it can be stabilized and the degree of vacuum measuring device which can be mass-produced can be offered. Moreover, since the corrosion prevention film was prepared in the filament from claim 5 of this invention according to claim 7, the degree of vacuum measuring device which enables use in a corrosive gas ambient atmosphere can be offered.

[0041]

---

[Translation done.]

\* NOTICES \*

JPO and NCIPI are not responsible for any damages caused by the use of this translation.

1. This document has been translated by computer. So the translation may not reflect the original precisely.
2. \*\*\*\* shows the word which can not be translated.
3. In the drawings, any words are not translated.

---

DRAWINGS

---

[Drawing 6]

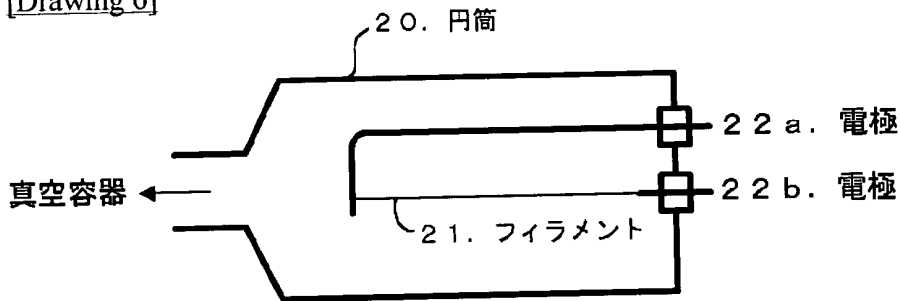

[Drawing 1]

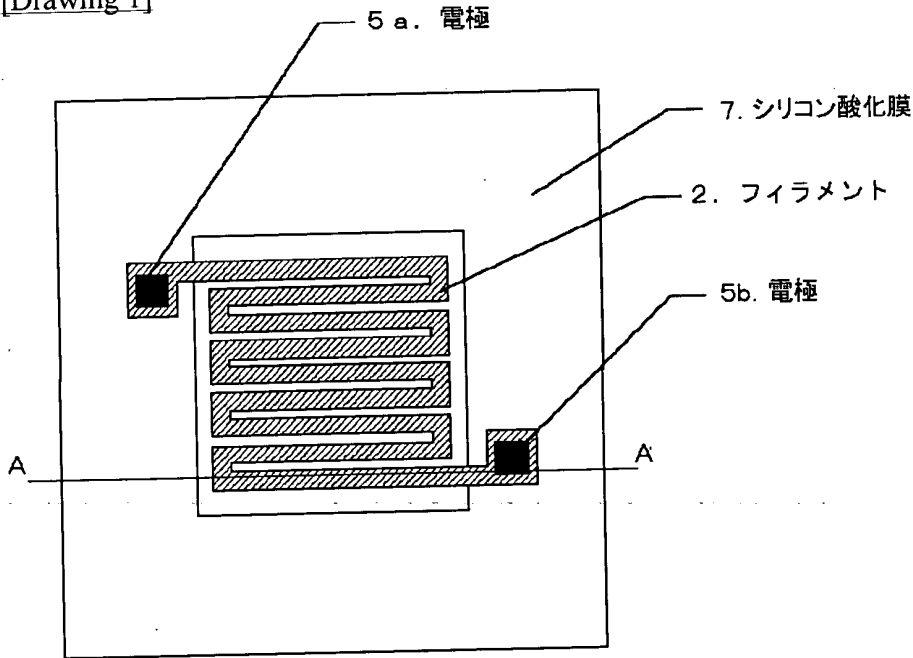

[Drawing 3]

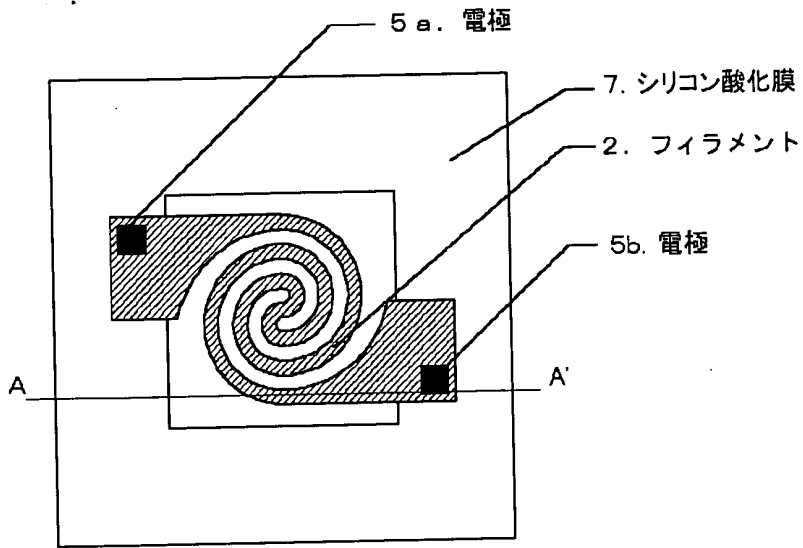

[Drawing 2]

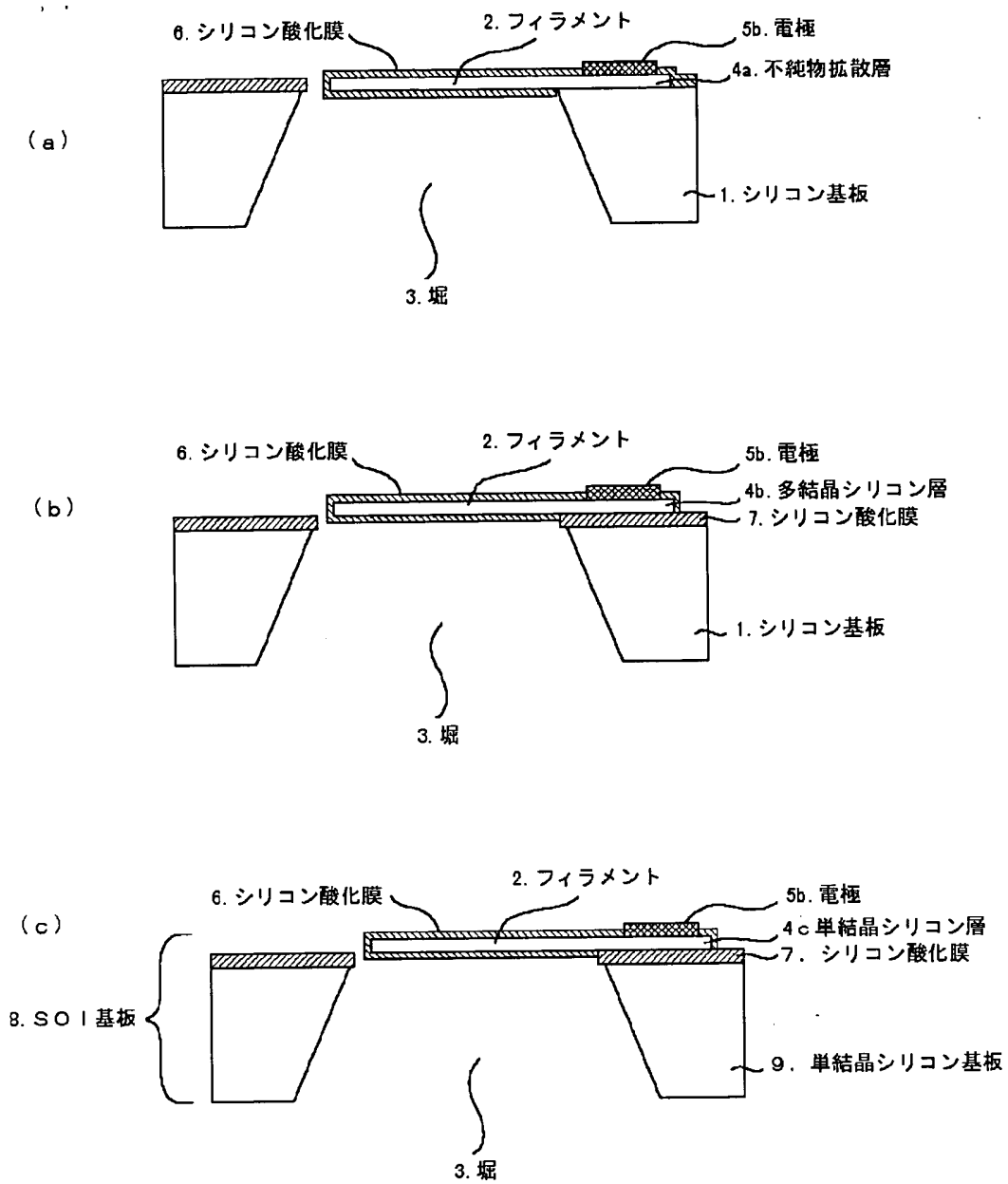

[Drawing 4]



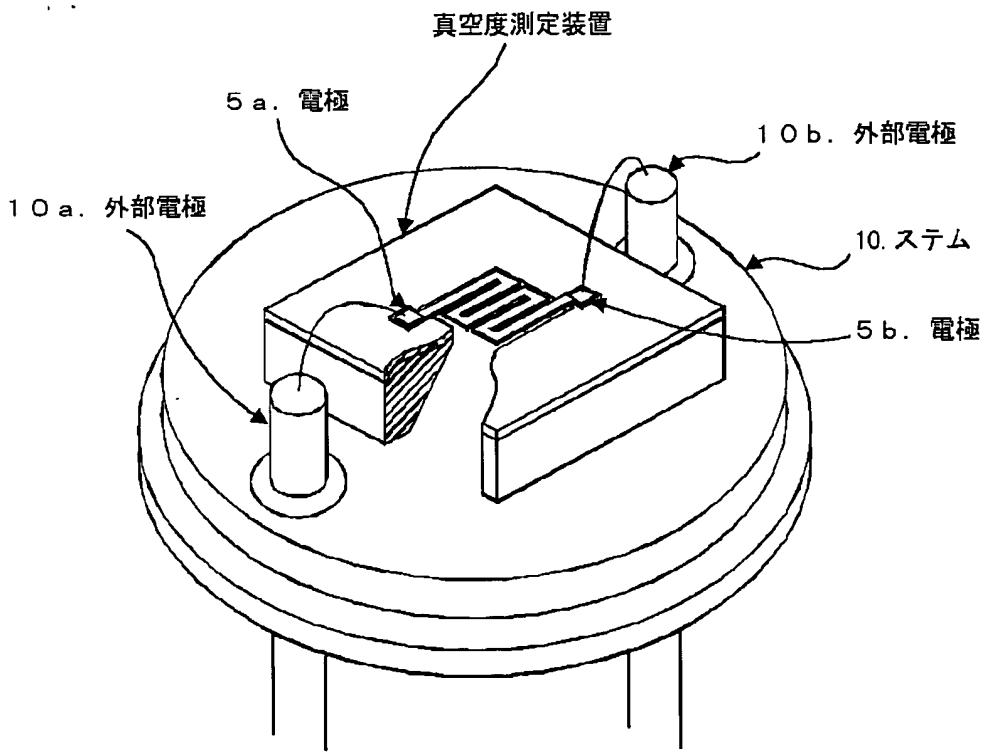

[Drawing 5]

電圧変化率の真空度依存性

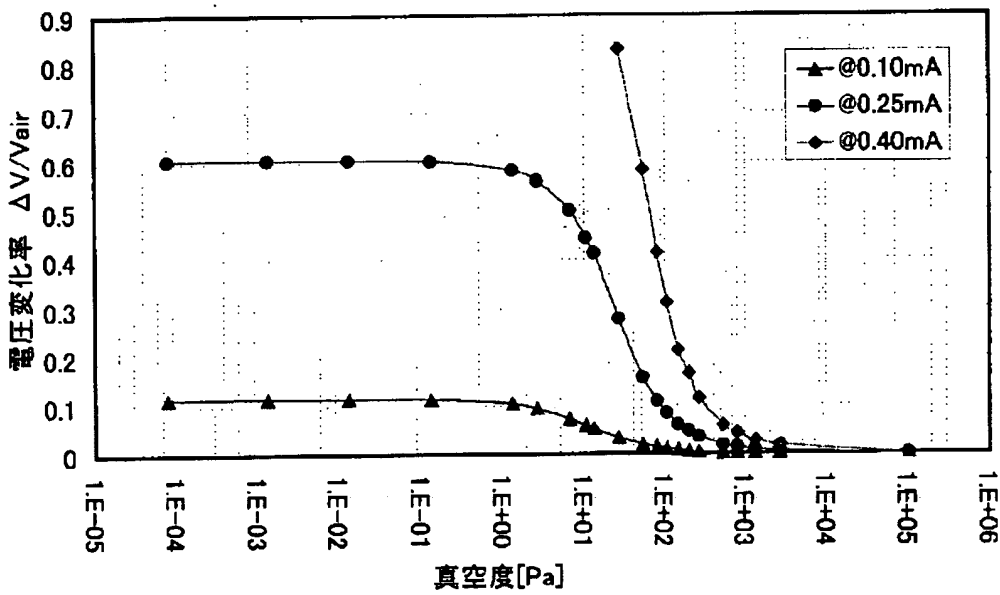

[Translation done.]